

audio-technica



ATUC-50

Full-Featured Digital Conference System



ATUC-50 A New Class of Conferencing

ATUC-50 Key benefits

- Feedback suppression and individual DSP for enhanced audio quality
- Premium Sound quality and speech intelligibility
- Multi-lingual web remote based remote control
- Paintable top panel
- Plug and play installation
- Five Year Warranty
- Secure and reliable
- Cost effective
- Ease of use



5 YEAR
WARRANTY



ATUC-50 A New Class of Conferencing

You choose the scale and complexity of your communication needs and in return the ATUC-50 Discussion System gives you reliable, crystal-clear speech reproduction from a system that couldn't be simpler to set up and use.

From small gatherings in a meeting room to medium/large-scale conferences, the ATUC-50 is designed to be easily configured – and reconfigured – while providing the professional sound quality and advanced controls that will enable you to adapt it to any number of discussion settings.

The ATUC-50 is the first with individual DSP for each discussion unit for real-time adjustment during conferences. The premium audio performance and high intelligibility results in a more engaging and less tiring conference experience. The system is easy to operate via a PC, mac or any tablet (windows, iOS, android), and the intuitive web remote control works on all web browsers.

The ATUC-50 enables full IP integration into 3rd party control systems. More functionality, higher performance and better value than other products.



ATUC-50 System Components



Control Unit ATUC-50CU



The heart of the ATUC-50 system

- Supports up to 100 discussion units.
- Cascade capability to handle upto 300 discussion units and a max of six interpretation units for upto 3 spoken languages in the meeting.
- 4 configurable balanced outputs plus output 1 mirrored to unbalanced output.
- 2 Mic/Line In + 1 Aux In + 2 Return In.
- Three language simultaneous interpretation.
- Conference Mode: Free talk, Request to talk and Full remote.
- Override settings: LIFO, FIFO and Non Override.
- 'Mic On' trigger: Manual or Voice activation.
- Web remote interface facilitates pre-meeting system setup and management of the live discussion through a web browser.
- Built-in Wav and MP3 Recorder to external USB memory devices, up to 4 channels (2 channel MP3).
- Built-in feedback suppressor and digital audio processing (DSP).
- Gain sharing algorithm substantially reduces the risk of feedback while maintaining a natural sound.

Specifications

I/O connectors	Inputs: MIC/LINE x 2, AUX (ST), Interpretation Return x 2 Outputs: Balanced x 4, Unbalanced x 1 LINK/CHAIN: DU A/B terminals, CU A/B terminals (DU C/D terminals)
Recording (via USB)	WAV: 1/2/3/4 track with CUE point (BWF standard) MP3: 1/2 track with CUE point (Original format) MP3 bit rate: 64kbps / 128kbps / 192kbps / 256kbps / 320kbps
Resolution/Sampling frequency	24bit/48kHz
Latency	1ms *MIC Input to Output / 1.2ms *DU to CU
Frequency response	+ 1.0, - 2.0dB, 20Hz-20kHz, refer to +4dBu output @ 1kHz
Dynamic range	110dB A-weighted
Signal to noise	90dB A-weighted
Headroom	20dB
Equivalent input noise	Mic/Line 1-2, less than -126dBu, Rs=150 ohm
Residual noise	Less than -86dBu, A-Weighted
Total harmonic distortion	Less than 0.03% @1kHz unity
Crosstalk @1kHz	Less than -80dB
OLED display	20x2 Character type, Color: Yellow, Operating life time: 100,000 hours
Phantom power	DC +48V
Power requirement	AC 100V-240V 50/60Hz
Power consumption	20W - 175W (max.)
Operation temperature	0-40°C
Operation humidity	25 - 85%
Dimensions (1 RU)	482.6mm x 331.6mm x 44mm (W x D x H)
Net weight	3.4kg
Finish	Front panel - Black, Top & Rear - Black
Included accessories	AC power cord, Quick Setup Guide x 2, Euroblock connectors x 9, Warranty Sheet

Specifications are subject to change without notice.

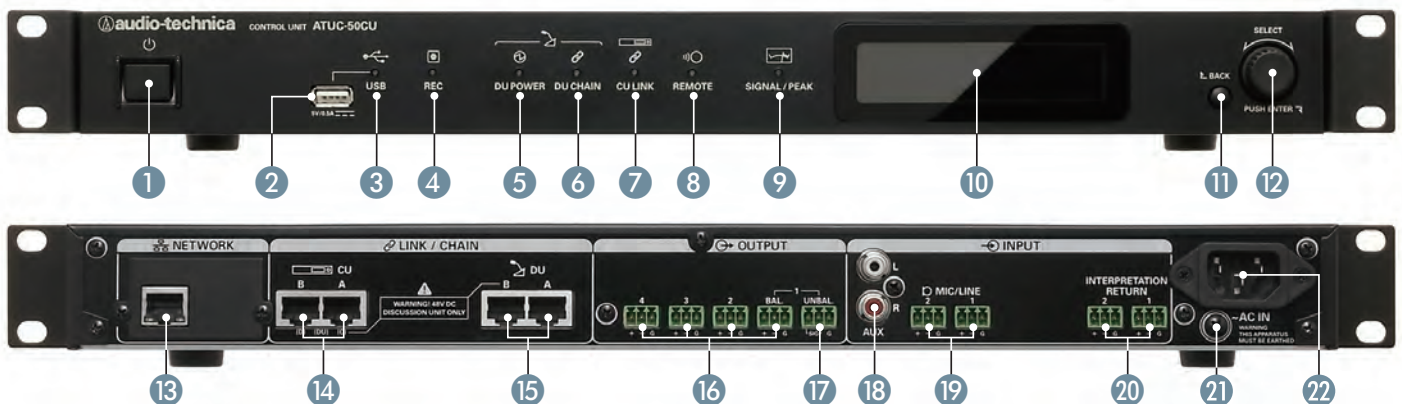

- | | | | |
|--|-------------------------------------|---|--|
| 1 Power switch | 7 CU LINK indicator | 15 NETWORK terminal | 18 Analog input (unbalanced) terminal |
| 2 USB (for a USB flash drive) terminal | 8 Remote (remote control) indicator | 14 CU LINK A/B terminals,
DU CHAIN C/D terminals | 19 Analog input (balanced) terminal |
| 3 USB access indicator | 9 SIGNAL/PEAK indicator | 16 Analog output (balanced) terminal | 20 Interpretation return inputs (balanced) |
| 4 REC (recording) indicator | 10 CU display | 17 Analog output (unbalanced) terminal | 21 Ground screw |
| 5 DU POWER (DU power supply) indicator | 11 BACK button | | 22 AC Inlet (AC IN) |
| 6 DU CHAIN indicator | 12 Jog dial/ENTER button | | |

Web Remote Control

ATUC-50

Discussion unit with high-quality audio

The ATUC-50's Web Remote Control function is a web application with a multi-language UI that allows you to configure and operate the system from a computer or mobile device using a standard web browser and without needing to load software. From the application's home screen it is possible to configure detailed settings of the system, recall and adjust presets before starting a conference.

- Accessible from web browser on Mac, PC, iOS and Android tablets.
- No need to install additional software.
- Intuitive licence free software based on Google Material design principles.
- Multi lingual user interface (with a choice of 10 preloaded languages and the possibility to upload two additional languages).
- General system settings with the system upgrade facility.
- Network settings.
- Administrator and Operator access levels, with optional password protection.
- Configuration of conferencing and audio parameters for the control unit.
- General and individual discussion unit (ATUC-50DU) and integration unit (ATUC-50IU) settings.
- Assignment of the preprogrammed functionalities to the GPIO's of the priority ATUC-50IU integration units.
- Configuration of the interpretation settings.
- Configuration of recording settings and control of (start, stop, pause) recording sessions.
- Creation of conference presets.
- Three different audio special effects, assignable for each preset.

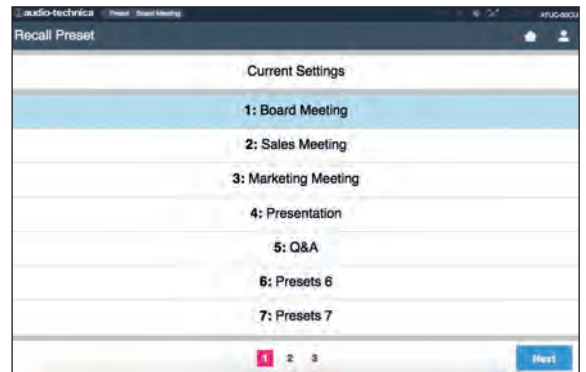

Preset

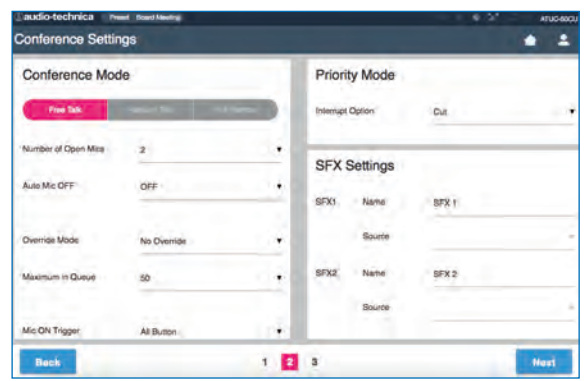

Conference Setting

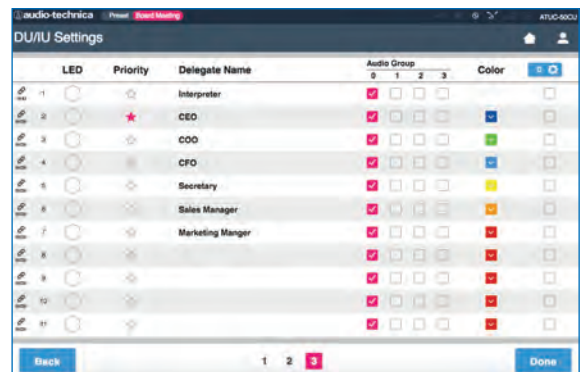

Discussion Unit Setting

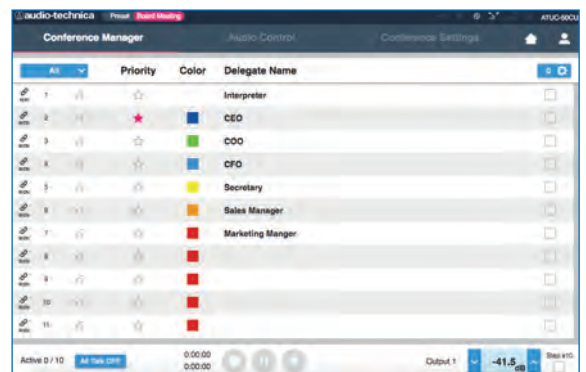

Conference Manager



ATUC-50 System Components

Discussion Unit **ATUC-50DU**

Discussion unit with high-quality audio

- Configurable user type unit e.g. delegate, chairman, VIP.
- Microphone connector compatible with standard 3-pin XLR microphones.
- Low Noise (EIN: -121 dBu) microphone preamp using discrete transistors, with individual adjustable gain control.
- Multi colour RGB rear LED bar for general visualisation purposes.
- Multi-colour LED on the speak button for user's colour preferences.
- LED display for volume control and listening channel selection.
- High quality speaker for enhanced speech intelligibility.
- 24-bit / 48kHz High Resolution Audio.
- Multiple independent indicator (multi-coloured RGB LED bar on rear of Discussion Unit and LED on the talk button).
- Clear LED display for volume control and listening channel selection.
- 2 x RJ45 Port for connecting to the Control Unit and other Discussion Units and 1x expansion terminal for future options.
- 1 x stereo mini jack headphone output.



Specifications

Dynamic range	107 dB A-weighted
Frequency response	+ 1.0, - 2.0dB, 20Hz - 20kHz, refer to +4dBu output @ 1kHz
Audio sampling	24 bit/48 kHz
Signal-to-noise	87 dB, A-weighted
I/O connectors	Inputs: MIC (Neutrik XLR-F) - Outputs: Headphones x 1 LINK/CHAIN: DU RJ45 A/B terminals
Headroom	20 dB
Equivalent input noise	Less than -121dBu, Rs=150 ohm
Total harmonic distortion	Less than 0.07% @1kHz unity
Phantom power	DC +24V
Power supply	DC +48V
Power consumption	2.2 W
Operation temperature	0-40° C
Operation humidity	25-85%
Dimensions (W x D x H)	135mm x 148.3mm x 84.2mm
Net weight	570g
Finish	Top panel: Charcoal grey - Enclosure: Black
Included accessories	Quick setup guide, warranty sheet

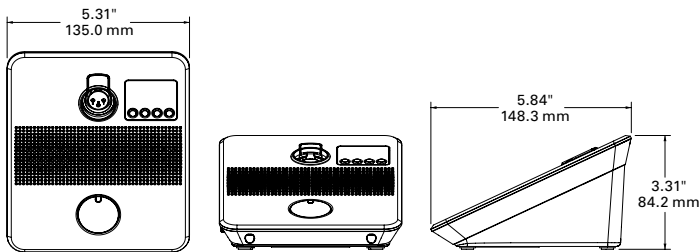

Microphones **ATUC-M43H** and **ATUC-M58H**

Specially designed 3-pin microphone with LED Ring

- Unique 3-pin balanced microphone with remote red LED ring offering high sound quality and user flexibility.
- Patent-pending design isolates the microphone connector from the Discussion Unit socket.
- Double layer pop filter (inside microphone and detachable wind screen).
- RFI-shielding technology offers outstanding rejection of radio frequency interference (RFI).
- Two lengths available (430mm, 580mm).

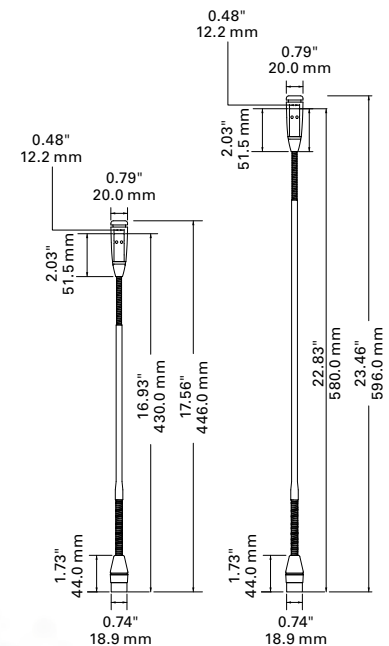

	ATUC-M43H	ATUC-M58H
Element	Fixed-charge back plate, permanently polarized condenser	
Polar pattern	Hypercardioid	
Frequency response	100-15,000Hz	
Open circuit sensitivity	-40 dB (10.0 mV) re 1V at 1 Pa	
Maximum input sound level	134 dB SPL, 1 kHz at 1% T.H.D.	
Signal-to-noise ratio	64 dB, 1 kHz at 1 Pa	
Impedance	250 ohms	
Finish	Low-reflectance black	
Dimensions	Ø18.9x430	Ø18.9x580
Weight	82g	92g

ATUC-50 System Components

Integration Unit **ATUC-50IU**

- The integration unit is a microprocessor unit for custom designed flush mount conference units.
- The unit is of compact robust metal casing with the fixing ears with holes, perfectly designed to fit the installation under the table, in-between the armrest of the chairs underneath the elevated floor or any other hidden place.
- With 39 Euro block pins the unit features an output for microphone with red lighting ring signalling, loudspeaker, minijack, 3 language channel selector for the headphone, volume control of the headphone output, speak button, priority/ mute button, 5V power outlet and 16 GPIOs.
- When the system is controlled by the CU via the web remote than the IU unit with no priority would have only one GPIO and that is the "self-mute"
- When the system is controlled by the CU via the web remote than the up to 9 IU units with priority can get assigned a variety of preprogrammed GPIOs such as: next on, master volume up and down, start and stop recording, up to 8 presets, up to 3 SFX - special sound effects.
- When the IP control is applied to the system the GPIO's of all the units regardless the priority level, can be custom programmed to the functionalities one's desires functionalities as e.g. external voting (up to 8 buttons) and many others.



Specifications

Dynamic range	106dB A-Weighted
Frequency Response	+1dB/ -2dB 20Hz – 20kHz, +4dBu input @ 1kHz
Audio Sampling	24bit / 48kHz
Signal-to-Noise Ratio	86dB, A-Weighted
Headroom	20dB
Phantom Power	DC +48V
Power Requirement	DC +48V
Power Consumption	3.4W
Operating Temperature	0 – 40°C
Connectors	2x RJ45, 39 pin on EuroBlock
Dimensions	116 x 173 x 25mm
Weight	460g



ATUC-50 System Components

Interpretation Unit **ATUC-50INT**

- This unit enhances the ATUC-50 system with 2 or 3 cost effective language simultaneous interpretation
- The unit in its simplicity does not require trained personae or extensive training to learn how to operate it.
- The unit has buttons for the incoming, out-going language choice and the control volume buttons
- Stereo mini jack outlet for the headphone and 3 pin XLR plug for the microphone
- The unit features both direct and relayed simultaneous interpretation
- There can be 2 units per language and in total 6 units in system
- The unit can be programmed to work either uni-directional L1 -> L2 or bi-directional L1 <->L2 way.
- With 2 INT unit per language it is possible to choose how would they interact one with each other: interlock, no-interlock or combine.
- The INT units can be seamlessly combined with any other contribution conference unit, DU and IU.



Specifications

Dynamic range	107 dB A-weighted
Frequency response	+ 1.0, - 2.0dB, 20Hz*20kHz, refer to +4dBu output @ 1kHz
Audio sampling	24 bit/48 kHz
Signal-to-noise	87 dB, A-weighted
I/O connectors	Inputs: MIC (Neutrik XLR-F) - Outputs: Headphones x 1 LINK/CHAIN: DU RJ45 A/B terminals
Headroom	20 dB
Equivalent input noise	Less than -121dBu, Rs=150 ohm
Total harmonic distortion	Less than 0.07% @1kHz unity
Phantom power	DC +24V
Power supply	DC +48V
Power consumption	2.2 W
Operation temperature	0-40°C
Operation humidity	25-85%
Dimensions (W x D x H)	135mm x 148.3mm x 84.2mm
Net weight	570g
Included accessories	Quick setup guide, warranty sheet

Link Extender **ATLK-EXT165**



- The ATLK-EXT165 provides additional power to the ATUC-50 system where the interactive connectivity chart indicates the placement the unit is required.
- The unit is equipped with the mains input, and 2 x RJ45 outlets
- The LED indicators indicate which chain is engaged and the red LED indicates that the unit is powered on
- The unit has a switch that enable remote switching on and off in relation to the ATUC-50CU.
- Robust metal cased unit is adapted to the placement in hidden places e.g under the floor, under the table, or wherever else the unit is required supply the ATUC-50 installation with required power.

Specifications

I/O Connectors	Outputs	LINK power status
	Chain	DU port A/B
Power requirement	AC 100V-240V 50/60Hz	
Power consumption	15W-160W (MAX)	
Operation temperature	0-40°C	
Operation humidity	25-85%	
Dimensions (W x D x H)	217mm x 326mm x 41mm	
Net Weight	2.2kg	
Finish	Front panel	Black
	Top & Rear	Black
Included Accessories	AC Power Cord, Quick Guide, Euroblock connectors (1pcs), Table mount kit, Warranty	

ATUC-50 A New Class of Conferencing

Simple, reliable and full-featured digital discussion system

Whatever your conferencing or discussion needs, the ATUC-50 is designed to offer reliable, clear and intelligible communication to significantly increase meeting efficiency and effectiveness.

Voice is the quickest and most efficient tool medium for exchanging ideas - whether in meeting rooms, in councils, in classrooms or through videoconference, speech is the most direct way of communication and understanding.

Audio-Technica's new wired ATUC-50 conference system is designed to offer a reliable and effective way to speak and to be heard.

Ease of use

Using standard Cat 5e (and above) cabling, the ATUC-50 system connects easily through a daisy chain or ring topology.

The Web Remote Control Interface allows quick and easy configuration, plus management directly from any web browser, without need to install dedicated software.

The on-board audio recorder can support up to 4 discrete channels for easy archiving without the need of an external recording device.

All settings can be saved as presets and easily recalled before the start of each meeting.

Reliability

For added redundancy the ATUC-50 can be configured using a ring topology.

The Web Remote Control Interface allows two user permission levels to avoid any unwanted access or accidental programming changes.

Flexibility

Advanced configuration can be used to tailor the system to the users' needs. Each configuration can be saved and recalled instantly.

Multiple modes such as 'Free Talk', 'Request To Talk', 'Full Remote'; various 'override settings': 'LIFO', 'FIFO' and 'Non Override'; and flexible 'Mic On trigger mode': manual or voice activation; allow for adaption to each and every situation.

IP Control allows full parameter access from most third party control systems.

Floor plus 2 Interpretation channels answer today's need in contemporary meeting rooms.

Sound quality and Speech Intelligibility

Individual Mic Gain and EQ to adjust each participant's voice.

24-bit/48kHz uncompressed digital audio for natural sounding voice reproduction.

12 band feedback suppressor allows higher volume levels without causing feedback.

Dynamic processing and 8-band parametric EQ on the main Analog output.

Wiring Diagrams

Daisy Chain x1 Chain

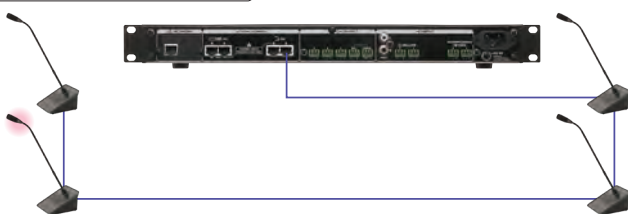

Daisy Chain x2 Chains

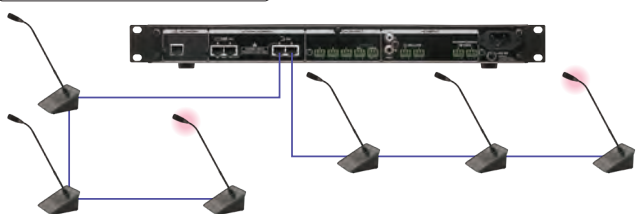

Ring Connection x1 Chain

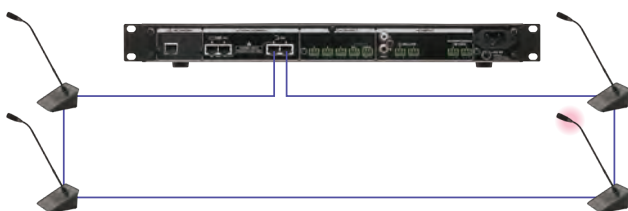

Ring Connection x2 Chains

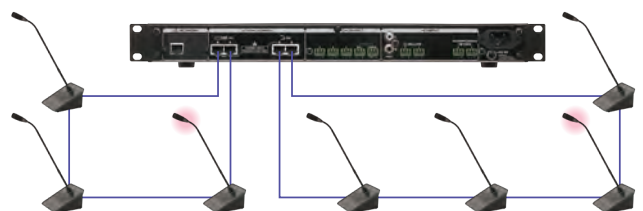

Ring Connection x1 Chain, Daisy Chain x1 Chain

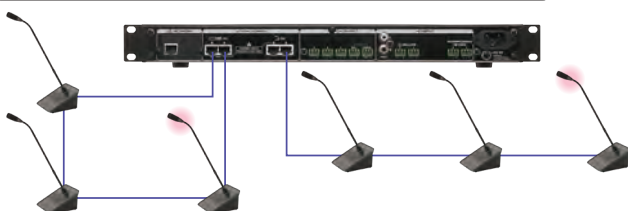

Daisy Chain x4 Chains

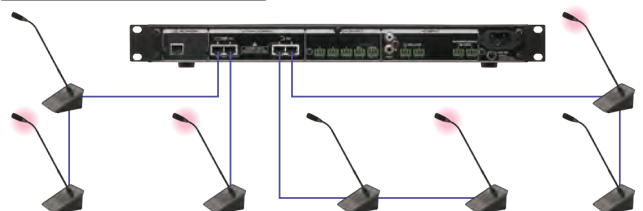



ATUC-50 System connection example

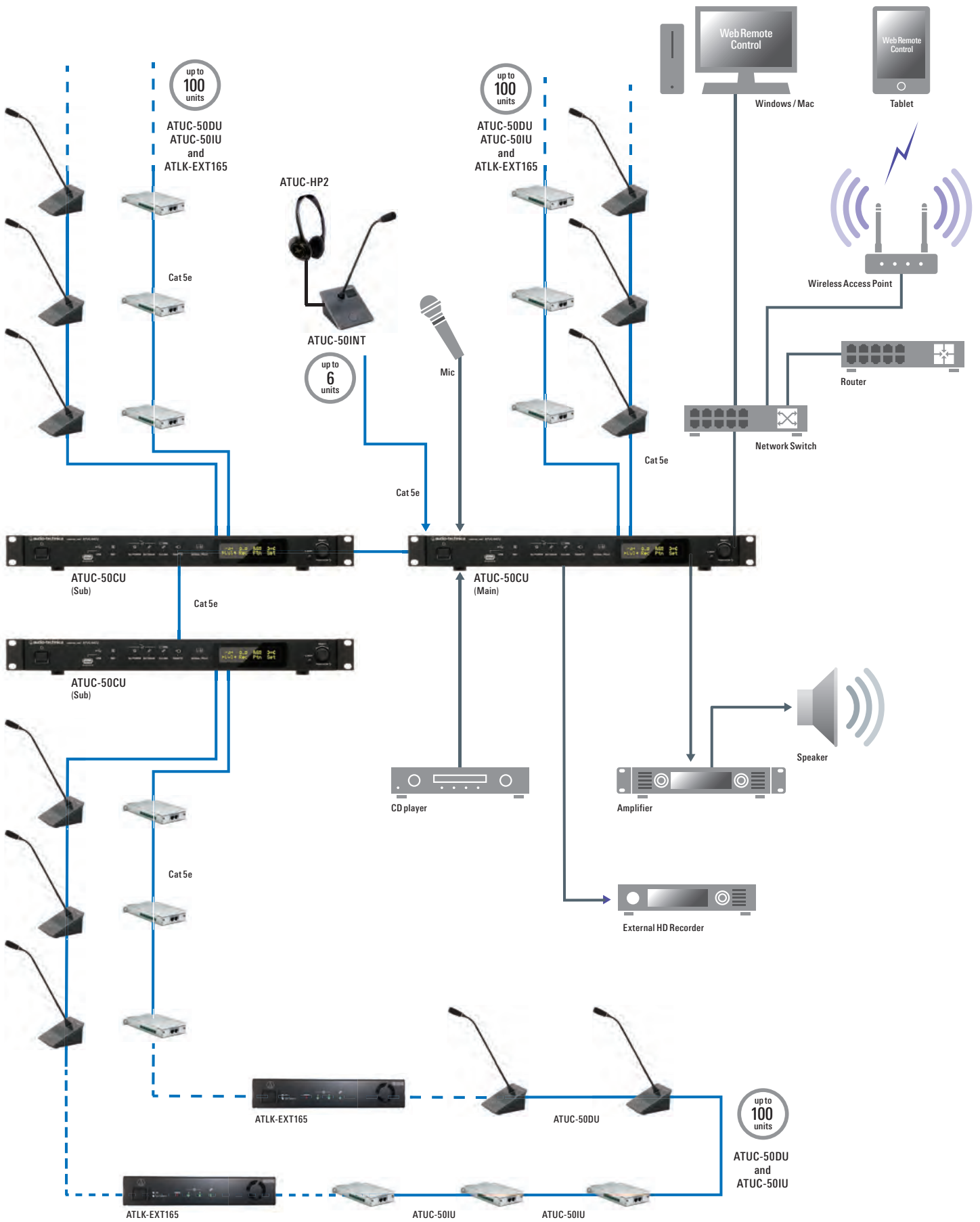

Audio-Technica UK
Audio-Technica Ltd.
Technica House
Unit 5, Millennium Way
Leeds, LS11 5AL
England

T: +44 (0)113 277 1441
F: +44 (0)113 270 4836

E: info@audio-technica.co.uk
eu.audio-technica.com

Audio-Technica Germany
Audio-Technica Deutschland GmbH
Peter-Sander-Str. 43 C
55252 Mainz-Kastel
Germany

T: +49 (0) 6134 25734 0
F: +49 (0) 6134 25734 50

E: info@audio-technica.de
www.audio-technica.de

Audio-Technica France
Audio-Technica SAS
11, rue des Pyramides
75001 Paris
France

T: +33 (0) 1 43 72 82 82
F: +33 (0) 1 43 72 60 70

E: info@audio-technica.fr
www.audio-technica.fr

Audio-Technica Spain
Audio-Technica Iberia SAU
Oficina Barcelona: Montserrat Roig 13
08908 L'Hospitalet de Llobregat
Barcelona, Spain
T: +34 935 222 450

Oficina Madrid: Fresadores 35
28939 Arroyomolinos, Madrid, Spain
T: +34 913 619 081

E: info@audio-technica.es
www.audio-technica.es

Audio-Technica Central Europe
Audio-Technica Central Europe Ltd.
H-1107 Budapest
Fogadó u. 3.
Hungary

T: +36 1 433 34 08
F: +36 1 431 90 06

E: info-ce@audio-technica.eu
www.audio-technica.hu

Audio-Technica Benelux
incorporating lemke Roos Audio
Audio-Technica Benelux B.V.
Kuiperbergweg 20
1101 AG Amsterdam
The Netherlands

T: + 31 20 6972121

E: info@audio-technica.nl
www.audio-technica.nl



audio-technica

©2019 Audio-Technica Ltd

E&OE*: Published specifications may be subject to change without notice.
(*Errors and Omissions Excepted)